

Care and Feeding of Telex Radio Dispatch Systems

IP-2002, C-6200, IP-223

IP-2002 Setup

Back Panel Connections

The IP-2002 **back panel connections**, shown in the Figure, are used to connect power and peripheral devices.

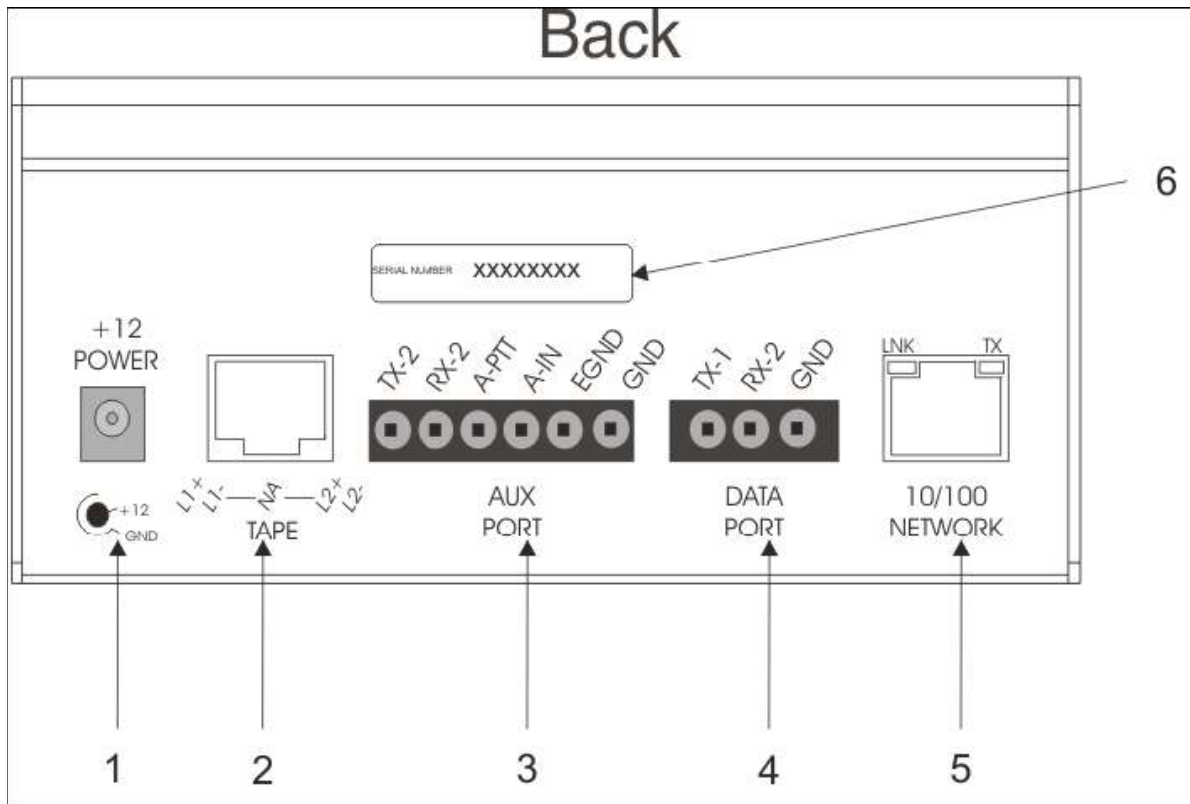

Dave Grant / dave@manoneng.com
425.827.7449

2/17/2009

Page 1 of 18



Care and Feeding of Telex Radio Dispatch Systems

IP-2002, C-6200, IP-223

IP-2002 Setup

- 1. Power Jack** - The power jack is used to connect the included power supply (2.5mm center positive plug) cord into the unit. The IP-2002 requires +12Vdc to +16Vdc to operate correctly.
- 2. Tape Port** - The tape port is used to connect an analog recorder with an RJ-45 connector that has Line 1 and Line 2 tape recorder outputs. Line 1 on pins 1 & 2, Line 2 on pins 7 & 8.
- 3. Auxiliary Port** - The auxiliary port takes audio from an external device to transmit over the network. *TX-2 and RX-2* - Pins 1 and 2 provide the secondary RS-232 port. This feature is currently not supported.
Auxiliary PTT - Pin 3 provides an alternate or auxiliary PTT input mechanism.
Auxiliary Audio Input - Pin 4 is an audio input used as the audio source when Aux PTT is pressed.
Earth Ground - Provides an Earth ground connection. For safety reasons, the use of earth ground is advised.
Digital Ground - Provides a ground connection for auxiliary PTT.
- 4. Data Port** - The data port is used to communicate between the console and computer. For more information on cable requirements, see “J3 3-Pin Cable” on page 30.
- 5. 10/100 Network (Ethernet) Port** - Standard RJ-45 Ethernet interface. Link and TX LEDs are built into the connector. This is NOT a **PoE** (Power over Ethernet) device.
- 6. Serial Number Label** - The IP-2002 Console serial number is printed on this label.

Dave Grant / dave@manoneng.com
425.827.7449

2/17/2009

Page 2 of 18



Care and Feeding of Telex Radio Dispatch Systems

IP-2002, C-6200, IP-223

IP-2002 Setup

Programming Mode Menu

The **Programming Mode** menu, shown in Figure 5, is accessed directly from the IP-2002 console. If an admin **PIN** (Personal Identification Number) has been set, then it will be required to enter programming mode; otherwise, no PIN is required. Once you are in the Programming Mode menu you can access the programmable menus to change the *clock (CLK)*, *IP Address and Subnet Mask (IP Setup)*, and *set a new PIN number (PIN)*.

NOTE: Only the admin has permission to upload new firmware to the IP-2002.

Dave Grant / dave@manoneng.com
425.827.7449

2/17/2009

Page 3 of 18



Care and Feeding of Telex Radio Dispatch Systems

IP-2002, C-6200, IP-223

IP-2002 Setup

To **access Programming Mode without a PIN**, do the following:

> On the IP-2002 keypad, press and hold the **G** button, Line 1's **MUTE** button, and the * button, in that order.

One of two menus appear on the console display PIN Login screen or Console Programming Mode.

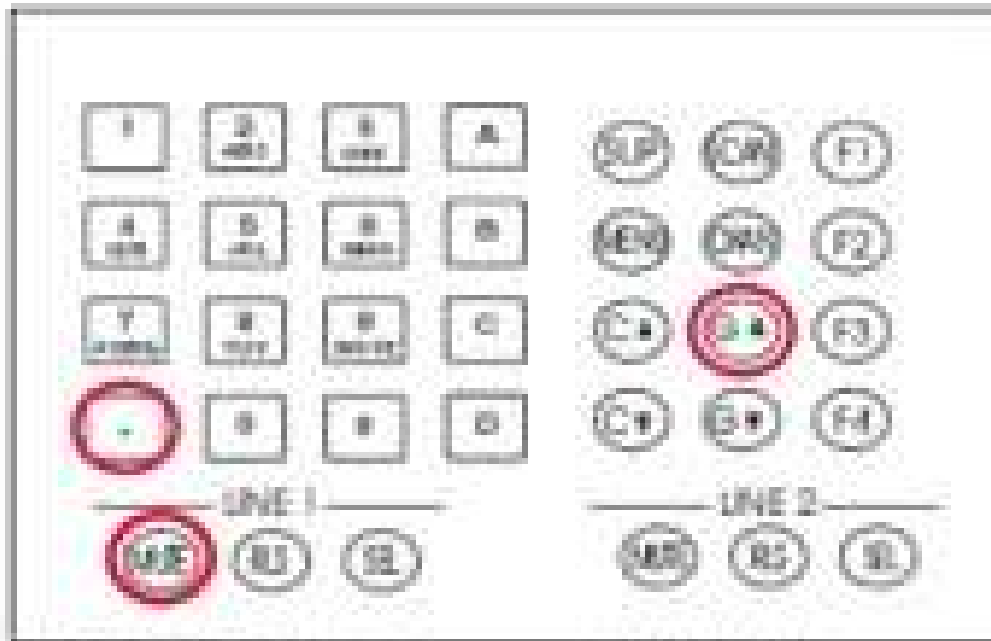

FIGURE 4. Enter Programming Mode Buttons

Dave Grant / dave@manoneng.com
425.827.7449

2/17/2009

Page 4 of 18



Care and Feeding of Telex Radio Dispatch Systems

IP-2002, C-6200, IP-223

IP-2002 Setup

PIN Login Menu

The IP-2002 comes with a programmable **PIN Login** menu, shown in Figure 5. Once an admin PIN has been set, it is required to access the Programming Mode menu.

To **login to Programming Mode with a PIN**, do the following:

1. On the IP-2002 keypad, press and hold the **G^** button, Line 1's **MUTE** button, and the * button, in that order.

One of two menus appear on the console display: PIN Login screen or Programming Mode, see Figure 5.

2. Using the DTMF keypad, enter the **admin PIN number**. *Asterisks appear, on the top line, for each character you enter.*

NOTE: To clear the entry press the **Clear** softkey.

NOTE: To exit without making changes, press the **Cancel** softkey.

3. Press the **OK** softkey.

Dave Grant / dave@manoneng.com
425.827.7449

2/17/2009

Page 5 of 18



Care and Feeding of Telex Radio Dispatch Systems

IP-2002, C-6200, IP-223

IP-2002 Setup

You are in programming mode.

PIN Login

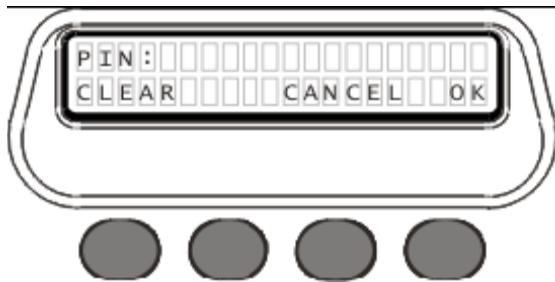

Console Programming Mode:

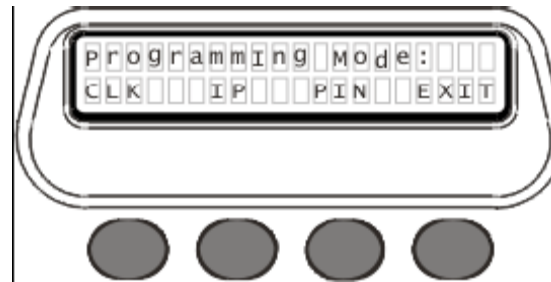

Programmable Menus

The **Programmable** menus are used to change the *CLK*, *IP Setup*, and *PIN* settings.

CLK Menu

The **CLK** menu, shown in Figure 6, is used to set the console clock, see Figure 6.

NOTE: For alternate method of setting the console clock, see “Alternate method: Set Quick Clock Mode”.

Dave Grant / dave@manoneng.com
425.827.7449

2/17/2009

Page 6 of 18



Care and Feeding of Telex Radio Dispatch Systems

IP-2002, C-6200, IP-223

IP-2002 Setup

To **set the console clock**, do the following:

1. On the IP-2002 keypad, press and hold the **G^** button, Line 1's **MUTE** button, and the ***** button, in that order.

One of two menus appear on the console display: PIN Login or Programming Mode, see Figure 5.

2. Using the DTMF keypad, enter the **admin PIN number**, if one is required.

Asterisks appear, on the top line, for each character you enter.

3. Press the **OK** softkey.

The Programming Mode menu appears.

4. Press the **CLK** softkey.

The clock menu appears. Options Edit, A/P, 12/24, and back appear.

5. Press the **12/24** softkey until *12hr* displays.

The 12-hour clock mode is selected. In the upper-right corner of the display, 12hr appears.

OR

Press the **12/24** softkey until *24hr* displays.

The 24-hour clock mode is selected. In the upper-right corner of the display, 24hr appears.

6. Press the **A/P** softkey to set the 12-hour clock time to *AM* or *PM*, if 12-hours clock mode is selected.

The time appears with AM or PM on the right.

7. Press the **Edit** softkey.

Dave Grant / dave@manoneng.com

425.827.7449

2/17/2009

Page 7 of 18



Care and Feeding of Telex Radio Dispatch Systems

IP-2002, C-6200, IP-223

IP-2002 Setup

The clock settings appear on the display.

8. Press the **Hours** softkey.

The Hours menu appears and displays the current setting.

9. Press the **12** softkey.

The clock resets to 12 hours or 1200 hours depending on selected mode.

10. Press the **dwn** or **up** softkey until correct hours displays.

The hour setting changes.

11. Press the **back** softkey after setting the hours.

The edit clock menu appears.

12. Press the **Mins** softkey.

The minutes menu appears and displays the current settings.

13. Press the **0** softkey.

The clock reset to 0 minutes.

14. Press the **dwn** or **up** softkey until correct minutes displays.

The minutes setting changes.

15. Press the **back** softkey after setting the hours and minutes.

The hour and minutes setting menu appears.

16. Press the **back** softkey.

The edit clock menu appears.

Dave Grant / dave@manoneng.com
425.827.7449

2/17/2009

Page 8 of 18



Care and Feeding of Telex Radio Dispatch Systems

IP-2002, C-6200, IP-223

IP-2002 Setup

17. Press the **back** softkey.

The Programming Menu appears.

18. Press the **EXIT** softkey.

The console displays, Resetting IP-2002. Changes are saved.

Alternate method: Set Quick Clock Mode

The **Quick Clock Mode** is used to change the console clock without having to log on to the Programming Mode menu.

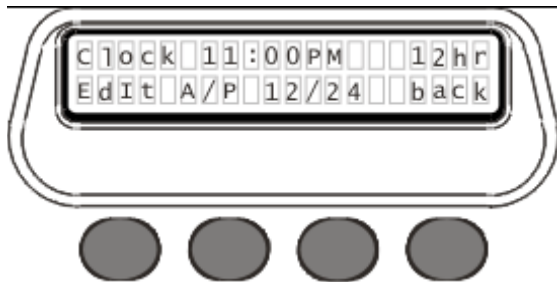

To set the console clock in quick mode, do the following:

1. Press and hold **Line 1's MUTE** button, **Softkey 1**, see Figure 5, and the * button, in that order.

The clock menu appears on the display, see Figure 6.

2. Follow steps 5–18 in “CLK Menu” on previous page.

Dave Grant / dave@manoneng.com
425.827.7449

2/17/2009

Page 9 of 18



Care and Feeding of Telex Radio Dispatch Systems

IP-2002, C-6200, IP-223

IP-2002 Setup

IP Setup Menu

The **IP Setup** menu, shown in Figure 7, is used to set both the IP Address and Subnet Mask of the IP-2002 console to allow communication between the console and web browser configuration.

NOTE: For an alternate method to set the IP Address and Subnet Mask with Microsoft® Hyper Terminal, see “Alternate method: Change IP Address and Subnet Mask” on page 30.

To **set or change an IP Address and Subnet Mask**, do the following:

1. On the IP-2002 keypad, press and hold the **G** button, Line 1’s **MUTE** button, and the * button, in that order.

One of two menus appear on the console display: PIN Login screen or Programming Mode, see Figure 5

2. Using the DTMF keypad, enter the **admin PIN number**, if one is required.

Asterisks appear, on the top line, for each character you enter.

3. Press the **OK** softkey.

The Programming Mode menu appears.

4. Press the **IP** softkey.

Dave Grant / dave@manoneng.com
425.827.7449

2/17/2009

Page 10 of 18



Care and Feeding of Telex Radio Dispatch Systems

IP-2002, C-6200, IP-223

IP-2002 Setup

The IP Setup menu, shown in Figure 7, appears on the display.

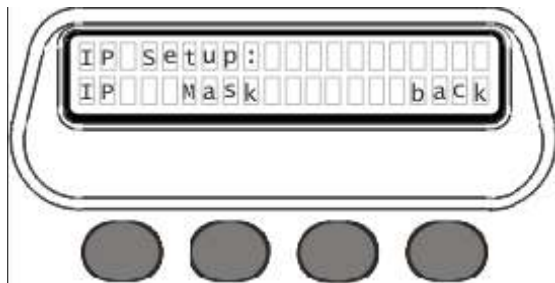

5. Press the IP softkey.

The IP menu appears.

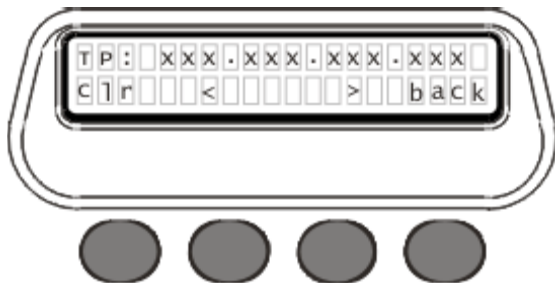

Dave Grant / dave@manoneng.com
425.827.7449

2/17/2009

Page 11 of 18



Care and Feeding of Telex Radio Dispatch Systems

IP-2002, C-6200, IP-223

IP-2002 Setup

6. Enter the **IP Address** you want to assign to the IP-2002 (use the * key for the dot between the octets).

7. Press the **back** softkey.

The IP Setup menu appears.

8. Press the **Mask** softkey.

NOTE: The following keys are used to enter the IP and Mask dotted quad once the IP or Mask menu is accessed.

DTMF 0–9 - The DTMF digits allow entry of the specific numbers.

*DTMF * or A* - DTMF “*” or “A” is the decimal point used in entering the octet.

Softkey 1 - The “Clr” function clears the entered value and starts over.

Softkey 2 - The < “backspace” function deletes the last entered number.

Softkey 3 - The > “forward space” function steps, to the right, past the next number.

Softkey 4 - The back softkey is pressed, once the IP Address has been entered.

9. In the Mask field, enter the **Subnet Mask** of the network to which the IP-2002 is connected (use the * key for the dot between the octets).

10. Once you are finished entering the Subnet Mask, press the **back** softkey.

The IP Setup programming menu appears on the console display.

11. Press the **back** softkey.

The Programming Mode menu appears on the console display.

Dave Grant / dave@manoneng.com

425.827.7449

2/17/2009

Page 12 of 18



Care and Feeding of Telex Radio Dispatch Systems

IP-2002, C-6200, IP-223

IP-2002 Setup

12. Press the **EXIT** softkey

IP-2002 Resetting, appears on the console display. It is now possible to connect to the IP-2002 using the web

browser. To access the IP-2002 web browser, see page 34.

NOTE: Press the **Clr** softkey to delete all characters from the display.

Press the **<** or **>** softkey to navigate between characters in the IP Address.

See your network administrator if you need help determining which IP Address to use.

PIN Setup Menu

The **PIN Setup** menu, shown in Figure 9, is used to delete, set new or change the existing admin PIN number. This is the same admin PIN as the web browser configuration admin PIN. When an admin PIN is set, the IP-2002 prompts for it before allowing changes.

NOTE: To set or change the admin PIN number with the web browser configuration, see “Account Setup” on page 59, or “Clone & PIN” on page 76.

To **set a new admin PIN number**, do the following:

1. On the IP-2002 keypad, press and hold the **G^** button, Line 1’s **MUTE** button, and the ***** button, in that order.

Dave Grant / dave@manoneng.com
425.827.7449

2/17/2009

Page 13 of 18



Care and Feeding of Telex Radio Dispatch Systems

IP-2002, C-6200, IP-223

IP-2002 Setup

One of two menus appear on the console display: PIN Login screen or Programming Mode, see Figure 5 on page 25.

2. Using the DTMF keypad, enter the **current admin PIN number**, if one is required.

Asterisks appear, on the top line, for each character you enter.

3. Press the **OK** softkey.

The Programming Mode menu appears.

4. Press the **PIN** softkey.

The PIN Setup menu appears.

5. Press the **New** softkey.

The PIN entry menu appears.

6. Using the DTMF keypad (0–9) enter a **new 4–16 digit PIN number**.

Asterisks appear for each number you enter.

NOTE: To delete the PIN entry from the console display, press the **CLEAR** softkey.

NOTE: To exit the menu and return to the PIN Setup menu without saving changes, press the **QUIT** softkey.

7. Press the **OK** softkey.

The confirm PIN menu appears.

Dave Grant / dave@manoneng.com
425.827.7449

2/17/2009

Page 14 of 18



Care and Feeding of Telex Radio Dispatch Systems

IP-2002, C-6200, IP-223

IP-2002 Setup

8. Using the DTMF keypad, reenter the **new PIN number**.

Asterisks appear for each number you enter.

NOTE: To exit the menu and return to the PIN Setup menu, without saving changes, press the **QUIT** softkey.

9. Press the **SAVE** softkey

The PIN Setup menu appears.

NOTE: If you enter the wrong PIN, an *Invalid PIN* message appears. To return to the PIN Setup menu, press the **OK** softkey.

10. Press the **back** softkey.

The Programming Mode menu appears.

11. Press the **EXIT** softkey.

Resetting IP-2002 message appears on the console display. A new admin PIN is set.

Dave Grant / dave@manoneng.com
425.827.7449

2/17/2009

Page 15 of 18



Care and Feeding of Telex Radio Dispatch Systems

IP-2002, C-6200, IP-223

IP-2002 Setup

To set the admin PIN to none required, do the following:

1. On the IP-2002 keypad, press and hold the **G** button, Line 1's **MUTE** button, and the * button, in that order.

One of two menus appear on the console display: PIN Login screen or Programming Mode.

2. Using the DTMF keypad, enter the **admin PIN number**, if one is required.

Asterisks appear, on the top line, for each character you enter.

3. Press the **OK** softkey.

The Programming Mode menu appears.

4. Press the **PIN** softkey.

The PIN Setup menu appears.

5. Press the **Clr** softkey.

Message, Clear PIN?, appears.

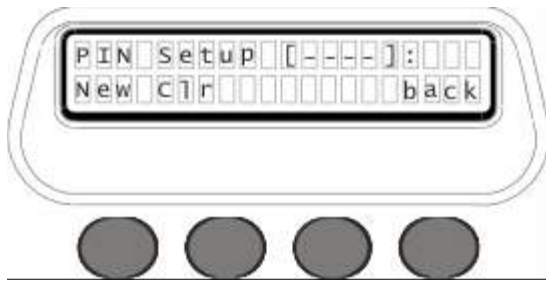

Dave Grant / dave@manoneng.com
425.827.7449

2/17/2009

Page 16 of 18



Care and Feeding of Telex Radio Dispatch Systems

IP-2002, C-6200, IP-223

IP-2002 Setup

NOTE: To exit the menu without clearing the PIN, press the **NO** softkey.

6. Press the **YES** softkey.

The PIN is cleared from the IP-2002 setup.

7. Press the **back** softkey.

The Programming Menu appears.

8. Press the **EXIT** softkey.

Resetting IP-2002 appears and changes are saved.

Alternate method: Change IP Address and Subnet Mask

An alternative to setting the IP Address and Subnet Mask from the IP-2002 console is to configure the settings with **Microsoft® Hyper Terminal**.

NOTE: Go to <http://www.hilgraeve.com/hpte/> for information about using HyperTerminal with Microsoft® Vista®.

Dave Grant / dave@manoneng.com
425.827.7449

2/17/2009

Page 17 of 18



Care and Feeding of Telex Radio Dispatch Systems

IP-2002, C-6200, IP-223

IP-2002 Setup

J3 3-Pin Cable

A **J3 3-Pin Cable** (not included) is required to reprogram the IP-2002 with an RS-232 terminal. The cable is connected to the computer (RS-232 port) and the 3-pin data port on the back of the console, for location see “IP-2002 Console Back”.

J3 3-Pin Data Port

Pin 1
Pin 2
Pin 3

RS-232 Port

DB-9 Pin
Pin 2
Pin 3
Pin 5

DB-25 Pin
Pin 2
Pin 3
Pin 7

Dave Grant / dave@manoneng.com
425.827.7449

2/17/2009

Page 18 of 18

